

RENTAL

**Smart  
metals**  
MOUNTING SOLUTIONS

# PRODUCT CATALOGUE

Innovative mounting  
solutions for  
projectors, flat panels  
& whiteboards



2020 - 2021 Product Catalogue - Rental



# WELCOME



## You just opened our Rental Catalogue

This catalogue is all about SmartMetals' mounting solutions specifically for rental purposes. Our product assortment is much larger and covered in separate catalogues mentioned below.

All catalogues are downloadable on [smartmetals.nl/downloads](http://smartmetals.nl/downloads). For a paper copy simply ask the SmartMetals Team.

## General Catalogue

Our General catalogue covers all mounting solutions for any installation purpose.



## Education Catalogue

In this catalogue we have collected all mounting solutions suitable for the education market.



# TABLE OF CONTENTS

Product Catalogue 2020 - 2021

## GENERAL

Prologue.....	4
Introduction .....	6

## RENTAL

### FLAT PANEL

#### FLAT PANEL - WALL-TRUSS MOUNTS..... 8

#### FLAT PANEL - STANDS & TROLLEYS..... 10

Light Series Stands & Trolleys.....	12
Heavy Duty Series Stands & Trolleys .....	14
Heavy Duty Series Stands & Trolleys back to back .....	16
Stage Stands, Light and Heavy Duty Series .....	18
Smart Screen Hoister with flightcase.....	20

#### FLAT PANEL - VIDEOWALLS..... 24

VideoWalls freestanding on the floor.....	25
---	----

#### FLAT PANEL - BRACKETS ..... 26

With three point coupling.....	26
Direct mounted bracket.....	31

### PROJECTOR

#### PROJECTOR - TRUSS MOUNTS ..... 32

Truss mounts with ball joint.....	33
Lightweight Truss Mounts with fine adjustment.....	34
Heavy Duty Truss Mounts with fine adjustment.....	35

#### PROJECTOR - STACK FRAMES..... 38

Small Series .....	39
Medium Series .....	40
Large Series.....	41

#### PROJECTOR - FLOOR STAND ..... 42

# AV MOUNTING MADE SMART

---



*What once started as a graduation assignment from only one student in Industrial Engineering & Management is now a thriving company with 50+ employees, dedicated to develop smart mounting solutions for the professional AV market.*

There is more to our mounts than just metal: we supply not just any piece of metal to mount your valuable audiovisual and multi media equipment to, we supply smart mounting solutions made of metals: "*SmartMetals Mounting Solutions*".

Smart does not only apply to the functionality of our products, smart also applies to the way we work. By closely following the evolutions and needs of the audiovisual market, listening to and closely working together with our customers we stay ahead of the game.

We take great pride in the fact that all our products, from standard to custom-made, are of Dutch design. Developed in house and manufactured in the Netherlands. Our products distinguish themselves in quality, ease of use and functionality.

Despite the fact we have grown into a prominent international supplier it does not mean we have forgotten where we came from: underneath the shimmering successes we remain simple humans. We care. Not just about making innovative products but above everything we care about you and your business.

*all team members of*

**The SmartMetals Team**





# ABOUT US

## SmartMetals explained

SmartMetals Mounting Solutions is one of the leading international suppliers of audiovisual mounting solutions. Established and based in the Netherlands, we deliver high quality solutions for professionals.

Resources devoted to R&D translate in great responsiveness in the development of innovative products, closely following the evolutions and needs of the audiovisual market and offering quality in design.

Our complete product range includes fixed and mobile mounting solutions, motorized or manually in height adjustable or on a fixed height for projectors, flat screens and whiteboards. We offer a free warranty of 5 years on all our products.

Last but not least we develop custom made solutions for audiovisual installation, including flat panel housings and kiosks, for indoor and outdoor use.



## WHY CHOOSE US?



### Quality & Functionality

Our goal is to reach true functionality in all our products by combining innovative product design with high quality materials and craftsmanship.



### Flexibility & Innovation

We respond to our customers' requests in a flexible way and timely manner. Developing and improving our products and services is a dynamic and continuous process.



### Quick & easy installation

All our products are designed to ensure quick and trouble-free installation in any environment.



### Honest business

We believe in honesty. We believe in caring. We treat our customers, partners, suppliers as well as our employees the way we would want them to treat us. As simple as that.

# Just because you don't find it, doesn't mean we don't have it.

We have all sorts of smart mounting solutions, ranging from standard to customised to completely custom-made ones. Not every project benefits from our standard solutions, nor does every customer settle for standard. When you are involved in a project where demands go beyond what our standard products have to offer, please contact us:

**We hear what you ask, listen to what you need and supply you with a solution that embodies just that.**



## STANDARD

We have a vast product range as presented to you in this catalogue: all standard mounting solutions for your flat panels, projectors and whiteboards, usually available from stock or within a few days after order.

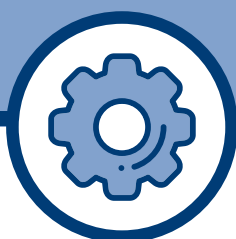

## CUSTOMISED

When you require a slight deviation of our standard product, like for example an other colour or an other length, we happily customise our standard product to meet your wishes.

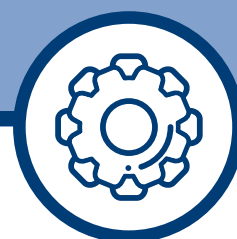

## CUSTOM-MADE

Although you have taken inspiration from our standard product range, you want something totally different. It is our pleasure to develop a custom-made product for you to accommodate your needs perfectly.

## FROM CONCEPT TO COMPLETION



### STEP 1

Product request.

You contact us with your request for a custom-made product. Together we determine product requirements and we provide you with an offer. Upon order we move on to the next step.



### STEP 3

Production.

Materials are purchased. Individual make parts are produced after which they are subjected to a provisional quality check.

**Process duration: 2-4 weeks**



### STEP 2

Specification drawing.

After order we will convert your demand and, if any, concept drawing into a detailed specification drawing. Upon presentation you check details and we will process minor changes if any. When you are satisfied with the results, you give us your approval for production.

**Process duration: 1-2 weeks**



### STEP 4

Finishing and assembly.

All manufactured metal make parts are galvanized or powder coated after which they are subjected to yet again a quality check. Then assembly starts followed by final testing the end-product. Remains only packing before collection by you or the carrier.

**Process duration: 1-2 weeks**



# WALL-TRUSS MOUNTS

The SmartMetals flat panel wall and truss solutions can be implemented in several ways: as a temporary installation of one flat panel, as a VideoWall solution with multiple flat panels, to a wall, in a truss or flying.

All solutions have been developed with focus on practicality and ease of use.

### BENEFITS



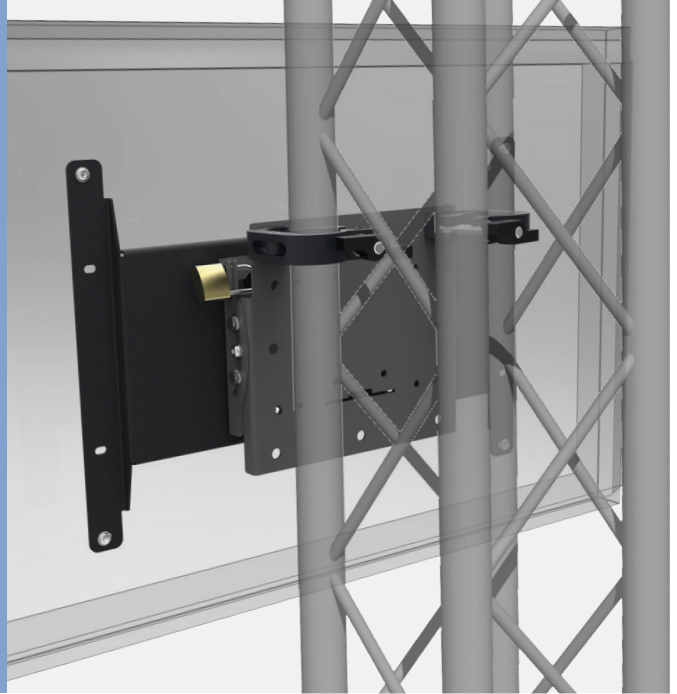

- ✓ For portrait and landscape
- ✓ Quick and easy to install
- ✓ Easy alignment

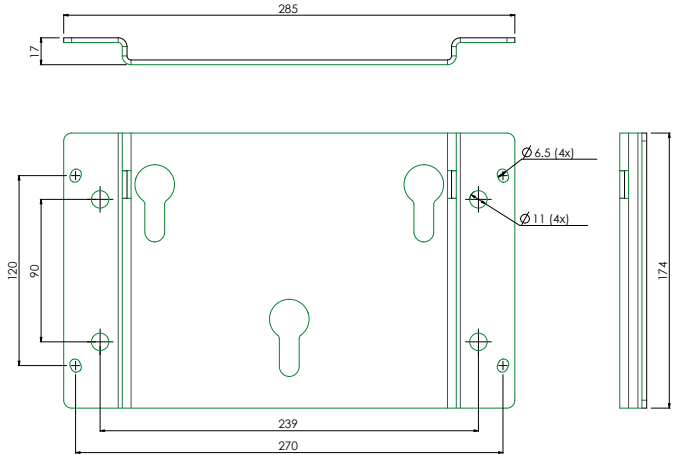
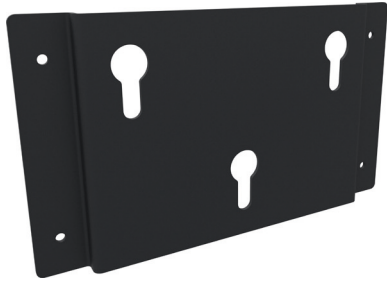

## FIXED WALL-TRUSS MOUNT FOR BRACKETS WITH THREE-POINT COUPLING



<b>Article code</b>
<b>063.0465</b>

 <b>Colour</b>	●
 <b>Max. load</b>	80 kg
 <b>Position</b>	Landscape & Portrait
 <b>Required</b>	Bracket, see from page 26
 <b>Other info</b>	Not suitable for use with 052.5050

**TILTABLE WALL-TRUSS MOUNT FOR BRACKETS WITH THREE-POINT COUPLING**

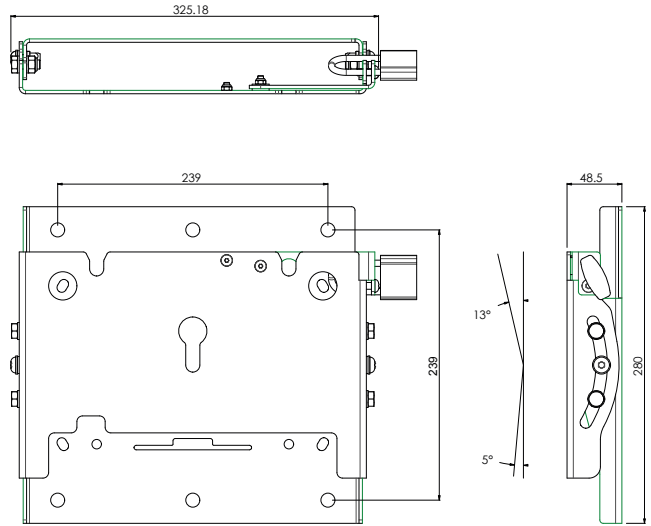
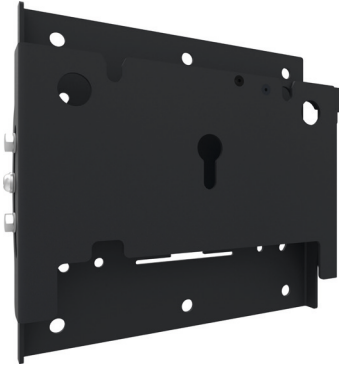

<b>Article code</b>
063.0460

 <b>Colour</b>	●
 <b>Max. load</b>	80 kg
 <b>Position</b>	Landscape & Portrait
 <b>Other info</b>	Excl. Doughty trigger clamps (2x 003.1128)

Accessories

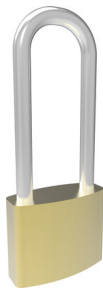

**PADLOCK 60MM**

To secure wall-truss module, housing and stand heads.

<b>Article code</b>
000.0013



**DOUGHTY TRIGGER CLAMP, MAX. 51 MM Ø**

The Doughty Trigger Clamp is used for truss mounting with the SmartMetals rental mounts (002.16xx, 002.2441, 002.2041) and the wall/truss module (art. nr.: 063.0460).

<b>Article code</b>
003.1128

# STANDS & TROLLEYS

## Benefits & Applications

SmartMetals offers a wide range of floor stands for rental purposes.

All stands and trolleys are fully divisible. Assembly is done without any tools and the stands are easily stored in a flightcase together with the flat panel for compact, practical and safe transportation.

All stand heads have three integrated keyholes which correspond to the three coupling bolts on our monitor brackets. The flat panel therefore is easily hung into the stand head.

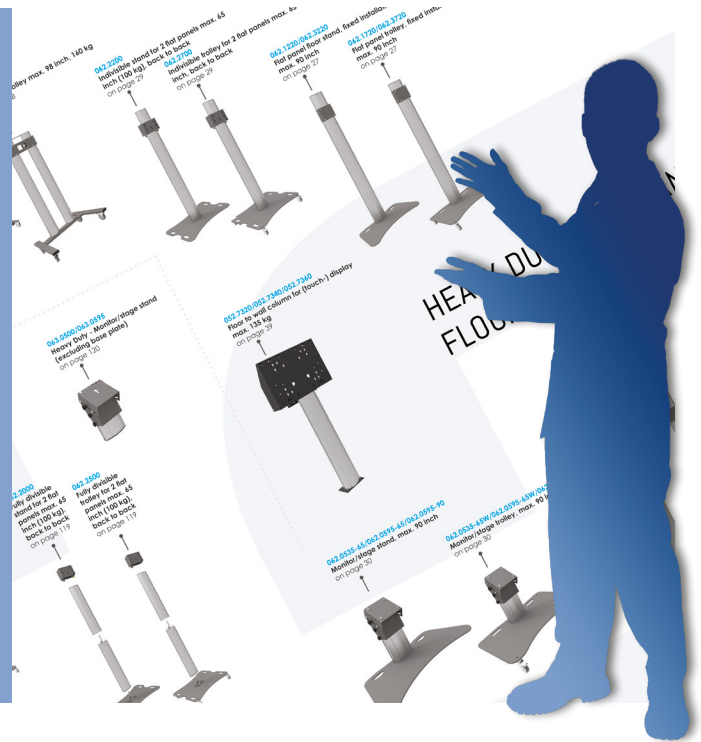

## Applications



### ON A BASE PLATE

For a freestanding installation of your monitor a floor stand on a base plate is what you are looking for. Our extensive range offers floor stands for light weight LED screens of max. 30 kg up to the heavy weight flat panels up to 160 kg.

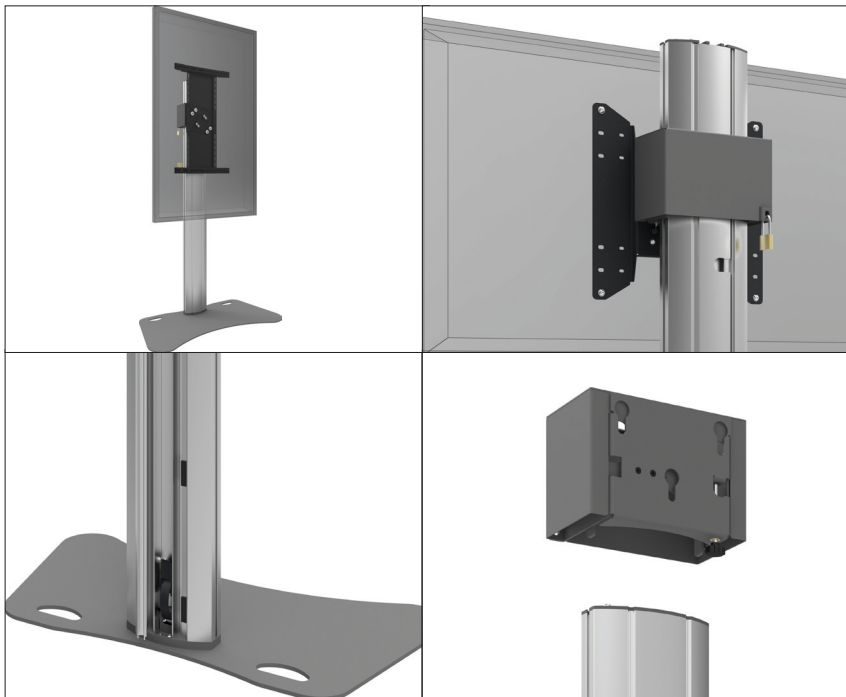

## BENEFITS

- ✓ For portrait and landscape screen position
- ✓ Suitable for flat panels up to 98 inch, max. 160 kg
- ✓ All solutions offer the possibility to protect your flat panel against theft
- ✓ All stands come with hidden cable management
- ✓ Short installation time thanks to three-point coupling
- ✓ Easy to level



## ON WHEELS

For the most flexible use of your floor stand in different spots and/or rooms the choice for a floor stand on wheels or so called trolley is obvious. Here also applies that our trolleys are available in Light and Heavy Duty models.



## BACK TO BACK

In our product range you will also find a floor stand for a freestanding back to back installation. This back to back floor stand is fitted with a stand head with three-point-coupling mounting system, to which a rental monitor bracket is easily mounted on both sides.

# LIGHT SERIES

## Stands & Trolleys

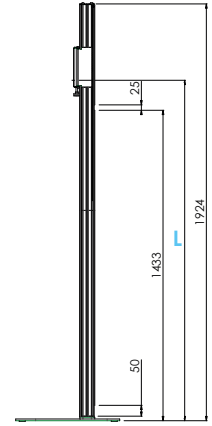
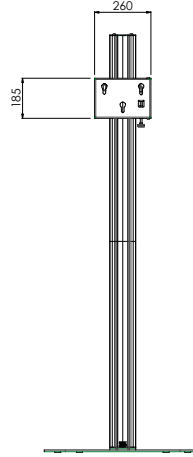
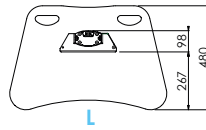
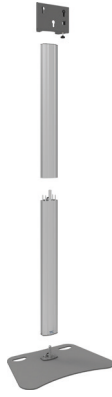

### DIVISIBLE STAND MAX. 55 INCH, 30 KG

	<b>Colour</b>	
	<b>Max. load</b>	30 kg
	<b>Max. inch</b>	55 inch
	<b>Position</b>	Landscape & Portrait
	<b>Required</b>	Bracket, see from page 26
	<b>Accessories</b>	See page 21

Article code	L (L) max. (centre screen)	Base plate L (L) x W
<a href="#">062.8050</a>	1766 mm	725 x 480 mm
<a href="#">062.8050-225</a>	2116 mm	950 x 480 mm

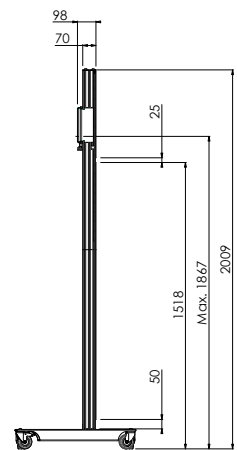
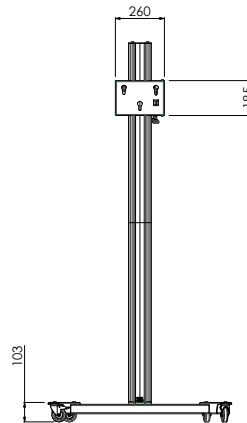
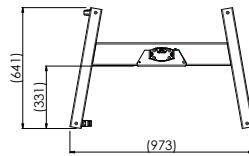
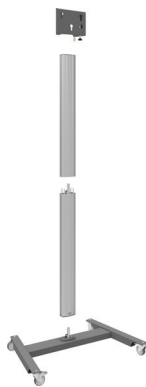

### DIVISIBLE TROLLEY MAX. 55 INCH, 30 KG

	<b>Colour</b>	
	<b>Max. load</b>	30 kg
	<b>Max. inch</b>	55 inch
	<b>Position</b>	Landscape & Portrait
	<b>Required</b>	Bracket, see from page 26
	<b>Accessories</b>	See page 21

Article code
<a href="#">062.8550</a>

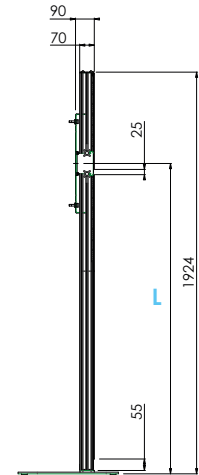
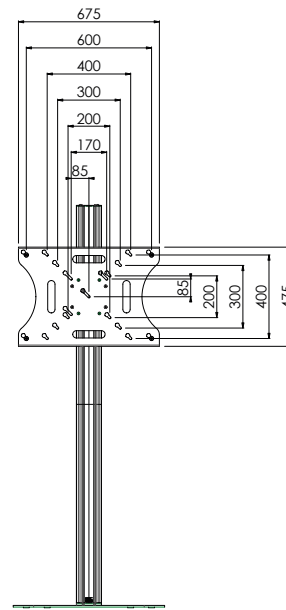
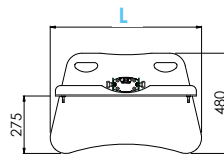
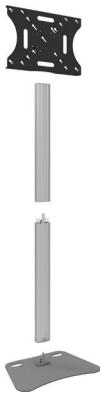

## DIVISIBLE STAND INCL. BRACKET MAX. VESA 600 X 400

	<b>Colour</b>	●
	<b>Max. load</b>	30 kg
	<b>Max. inch</b>	55 inch
	<b>Position</b>	Landscape & Portrait
	<b>VESA</b>	Max. VESA 600 x 400
	<b>Accessories</b>	See page 21

Article code	L (L) max. (centre screen)	Base plate L (L) x W
062.8045	1486.5 mm	725 x 480 mm
062.8045-225	1836.5 mm	950 x 480 mm

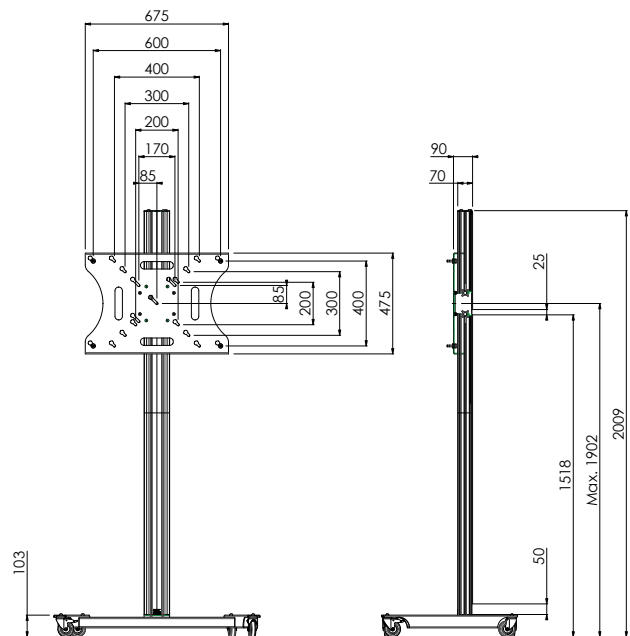
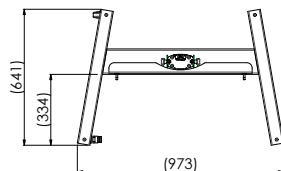
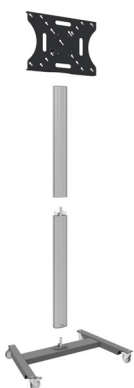

## DIVISIBLE TROLLEY INCL. BRACKET MAX. VESA 600 X 400

	<b>Colour</b>	●
	<b>Max. load</b>	30 kg
	<b>Max. inch</b>	55 inch
	<b>Position</b>	Landscape & Portrait
	<b>VESA</b>	Max. VESA 600 x 400
	<b>Accessories</b>	See page 21

Article code
062.8545

# HEAVY DUTY SERIES

## Stands & Trolleys

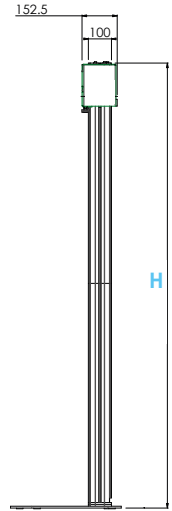
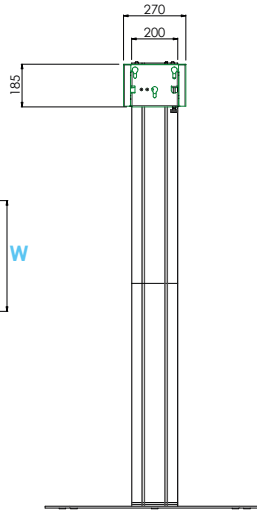
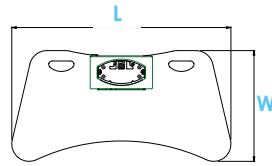
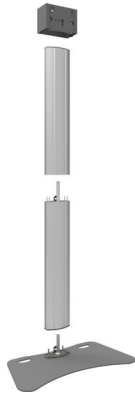

### DIVISIBLE FLOOR STAND

<b>Colour</b>	
<b>Position</b>	Landscape & Portrait
<b>Required</b>	Bracket, see from page 26
<b>Accessories</b>	See from page 22

Article code	Max. load	Height (H)	Base plate L (L) x W (W)	Inch range
062.1000	60 kg	1929 mm	950 x 480 mm	max. 65 inch
062.3000	85 kg	1929 mm	1140 x 576 mm	max. 90 inch
062.3000-225	85 kg	2279 mm	1140 x 576 mm	max. 90 inch

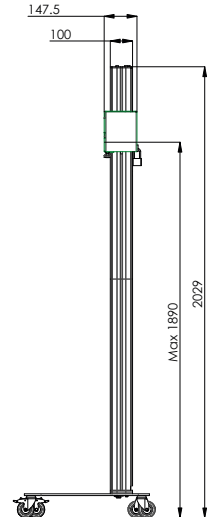
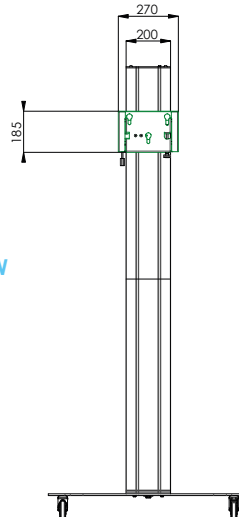
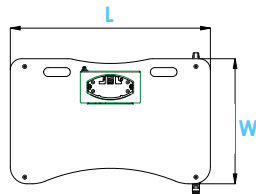
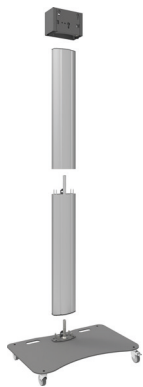

### DIVISIBLE TROLLEY

<b>Colour</b>	
<b>Position</b>	Landscape & Portrait
<b>Required</b>	Bracket, see from page 26
<b>Accessories</b>	See from page 22

Article code	Max. load	Base plate L (L) x W (W)	Inch range
062.1500	60 kg	900 x 563 mm	max. 65 inch
062.3500	85 kg	1100 x 663 mm	max. 90 inch

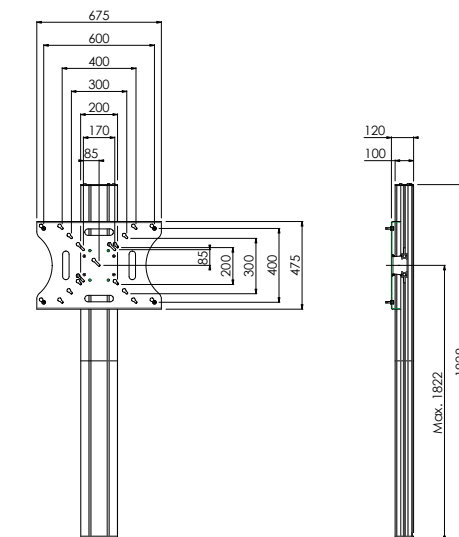
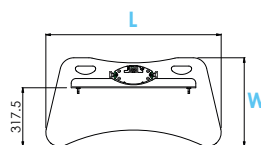
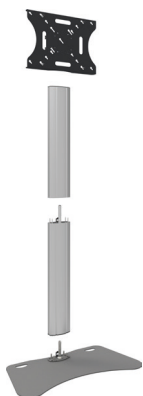

## DIVISIBLE STAND INCL. BRACKET MAX. VESA 600 X 400

Colour	
Position	Landscape & Portrait
VESA	Max. VESA 600 x 400
Accessories	See from page 22

Article code	Max. load	Base plate L (L) x W (W)	Inch range
<a href="#">062.1040</a>	60 kg	950 x 480 mm	max. 65 inch
<a href="#">062.3040</a>	85 kg	1140 x 576 mm	max. 90 inch

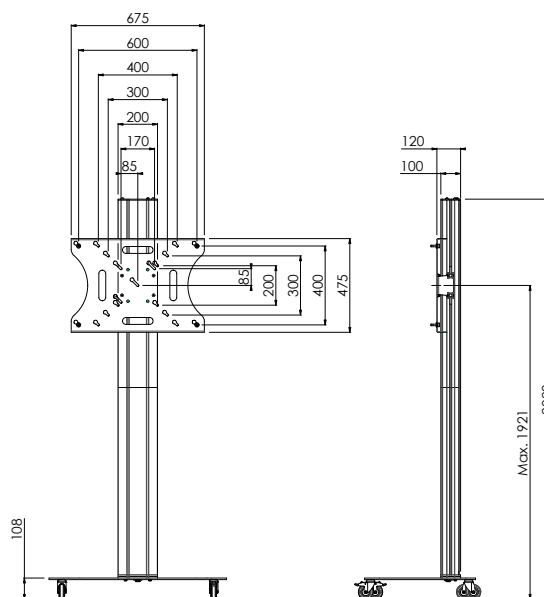
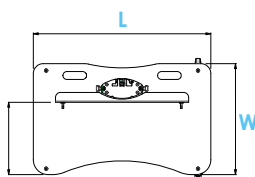
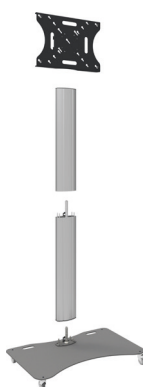

## DIVISIBLE TROLLEY INCL. BRACKET MAX. VESA 600 X 400

Colour	
Position	Landscape & Portrait
VESA	Max. VESA 600 x 400
Accessories	See from page 22

Article code	Max. load	Base plate L (L) x W (W)	Inch range
<a href="#">062.1540</a>	60 kg	900 x 563 mm	max. 65 inch
<a href="#">062.3540</a>	85 kg	1100 x 663 mm	max. 90 inch



# HEAVY DUTY SERIES

Stands & Trolleys back to back

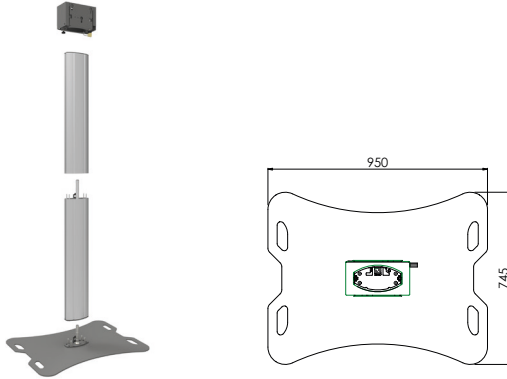

## FLOOR STAND BACK TO BACK

	<b>Colour</b>	
	<b>Max. load</b>	100 kg
	<b>Max. inch</b>	2x Max. 65 inch
	<b>Position</b>	Landscape & Portrait
	<b>Required</b>	Bracket, see from page 26
	<b>Accessories</b>	See from page 22

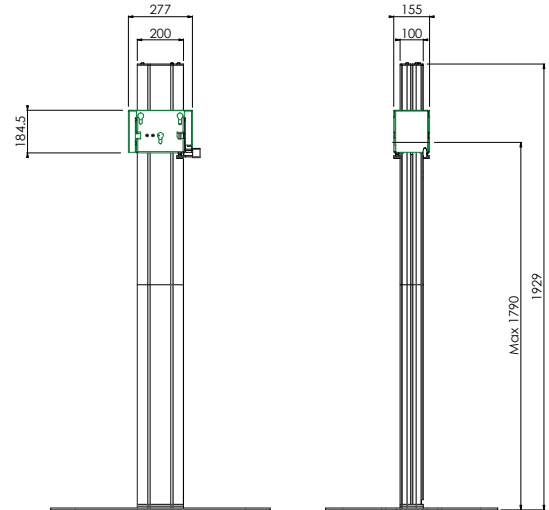

**Article code**

062.2000

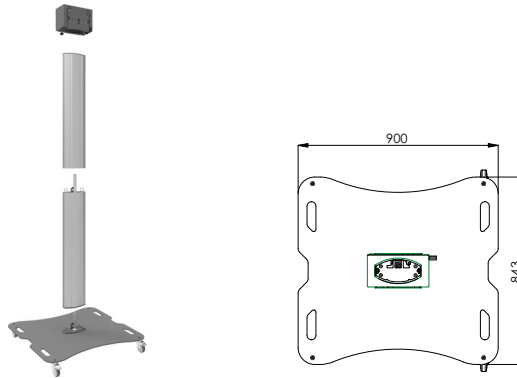

## TROLLEY BACK TO BACK

	<b>Colour</b>	
	<b>Max. load</b>	100 kg
	<b>Max. inch</b>	2x Max. 65 inch
	<b>Position</b>	Landscape & Portrait
	<b>Required</b>	Bracket, see from page 26
	<b>Accessories</b>	See from page 22

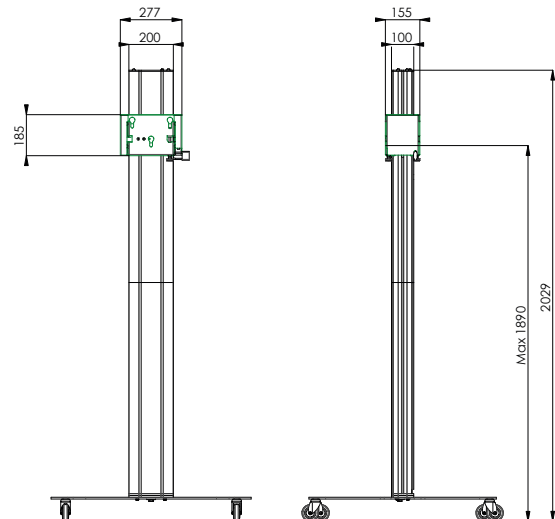

**Article code**

062.2500

“SMART  
& SOLID  
SAFE”

---

SmartMetals Mounting Solutions

# LIGHT & HEAVY DUTY SERIES

## Stage Stands

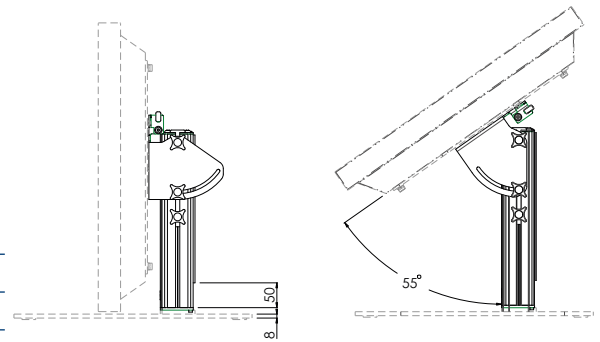
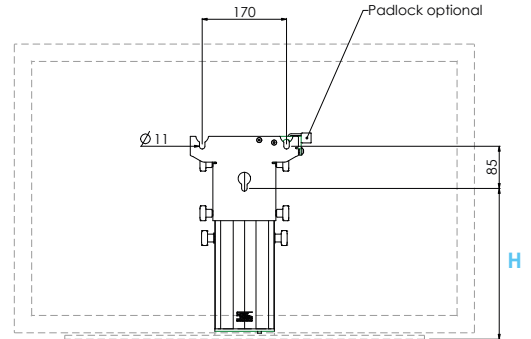

### LIGHT SERIES - STAGE STAND (EXCL. BASE PLATE)

	<b>Colour</b>	
	<b>Max. load</b>	30 kg
	<b>Max. inch</b>	Max. 55 inch
	<b>Position</b>	Landscape & Portrait
	<b>Required</b>	Bracket, see from page 26
	<b>Accessories</b>	See from page 21

Article code	Centre screen (H)
063.8635	304 mm
063.8695	904 mm

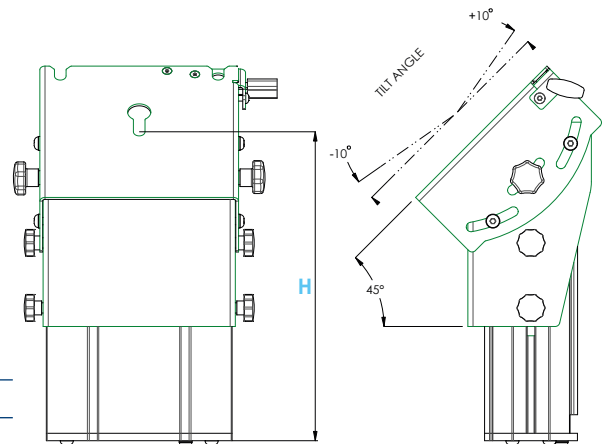
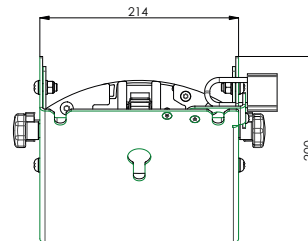

### HEAVY DUTY SERIES - STAGE STAND (EXCL. BASE PLATE)

	<b>Colour</b>	
	<b>Max. load</b>	80 kg
	<b>Max. inch</b>	Max. 65 inch
	<b>Position</b>	Landscape & Portrait
	<b>Required</b>	Bracket, see from page 26
	<b>Accessories</b>	See from page 22

Article code	Centre screen (H)
063.0500	333 mm
063.0595	1033 mm



## Confident performance

Our monitor/stage stands and trolleys are the perfect support whenever a confident performance is required.

Whether you are a public speaker, a priest who celebrates his Mass in church, a professor who teaches his class in an auditorium, anywhere you need a

confidence monitor you will find our products to be particularly useful offering a perfect viewing height and angle and stability.

All models are available in two heights and offer an adjustable viewing angle between 35° and 55°.

# ELECTRICAL DIVISIBLE STAND

Smart Screen Hoister with flightcase

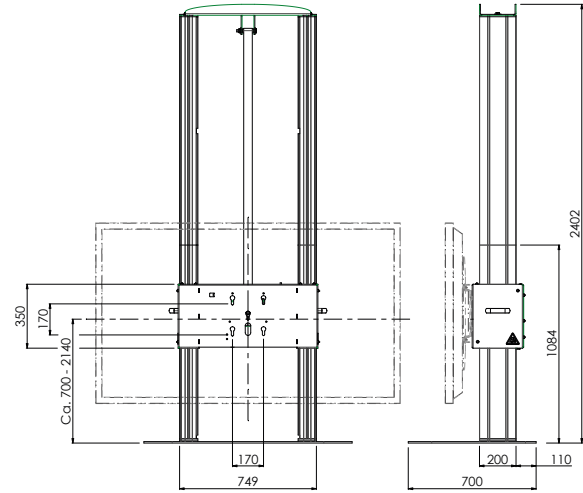

## USE AND TRANSPORT OF LARGE FORMAT DISPLAYS MADE EASY





This fully divisible stand with its flightcase is the perfect aid to transport and electrically hoist flat panels with a maximum weight of 120 kg.

With the integrated electrical hoist system it is very easy to hoist the monitor out of the flightcase up to the preferred height.

Add product 052.5075 with rotation function and you will also be able to rotate the screen from landscape to portrait position.

### Benefits

- ✓ Easy to install
- ✓ Health & Safety responsible use
- ✓ Effortless hoisting up to 120 kg
- ✓ Perfect aid to transport up to 120 kg load

 <b>Colour</b>	
 <b>Max. load</b>	120 kg
 <b>Position</b>	Landscape, Portrait
 <b>Required</b>	Bracket below

Article code	Inch range
062.7300-70	65 - 70 inch
062.7300-86	86 inch
062.7300-98	98 inch

## Accessory



### BRACKET WITH ROTATION

Universal rental bracket with rotation function and four point coupling. Max. load 160 kg.

<b>Article code</b>
052.5075

# ACCESSORIES

For Light Series Stands & Trolleys



## PADLOCK

Padlock 20 mm for securing the mounting head of your floor stand or trolley.

000.0001



## MINI-PC/THIN CLIENT HOUSING

max. 397 x 218 x 100 mm, lockable

063.0710



## STAND HEAD WITH THREE-POINT COUPLING

063.8020

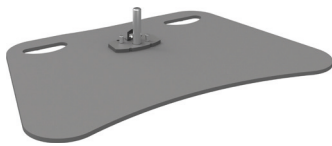

## BASE PLATE with pin

063.8055



## FLOOR FRAME on wheels with pin

063.8555

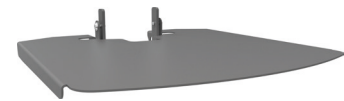

## LAPTOP SUPPORT

Article code	Description
063.8100	Surface 386 x 308 mm
063.8110	Surface 300 x 190 mm

For Heavy Duty Series Stands & Trolleys



## EXTENSION PIECES

for fully divisible stands

Article code	Description
063.0200	Stand extension piece 350 mm
063.0295	Stand extension piece 950 mm

# ACCESSORIES

For Heavy Duty Series Stands & Trolleys



## HOIST SYSTEM for divisible stand

This hoist system enables just one person to hoist a flat panel up to 90 kg out of a flightcase. After it is taken out of the flightcase, the monitor is mounted to a fully divisible stand and the hoist system is removed.

063.0600

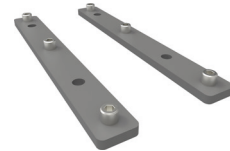

## EXTENSION SET HOIST SYSTEM set of mounting bars

063.0615



## EXTENSION SET HOIST SYSTEM hoist plate and roller-bar

In combination with the 063.0615 mounting bars this set enables the use of hoist system 063.0600 on multiple stands. This set can also be used as additional support for heavier screens (fitted with rental brackets) on the SmartMetals stands.

063.0610



## PADLOCK 60 MM for wall-truss module, housing, stand head

000.0013



front view

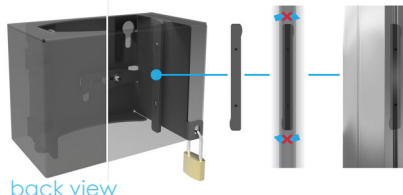

back view

## STAND HEADS

For mounting more flat panels to your stand you need an additional stand head and flat panel bracket (see page 26).

Stand head contains two clamping strips, designed to offer a perfect fit in the T-slots on both sides of the column, preventing the monitor from sagging.

Article code	Description
063.1020	For 1 flat panel
063.2020	For 2 flat panels back to back

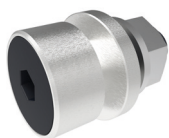

### COUPLING BOLT

15 mm, M8x30, ring and nut

**063.1039-M8**

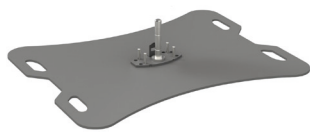

### BASE PLATE

Back to back 2x 65 inch,  
max. 100 kg (with pin)

**063.2010**

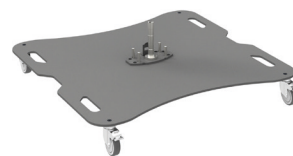

### BASE PLATE WHEELS

Back to back 2x 65 inch,  
max. 100 kg (with pin)

**063.2510**

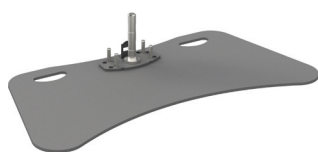

### BASE PLATES

Article code	Description
<b>063.1010</b>	Base plate for one flat panel up to 65 inch, max. 60 kg (with pin)
<b>063.3010</b>	Base plate for one flat panel up to 90 inch, max. 85 kg (with pin)



### BASE PLATES ON WHEELS

Article code	Description
<b>063.1510</b>	Base plate on wheels for one flat panel up to 65 inch, max. 60 kg (with pin)
<b>063.3510</b>	Base plate on wheels for one flat panel up to 90 inch, max. 85 kg (with pin)



### LAPTOP SUPPORTS

This laptop support can be mounted to the column over the full height and can be secured with a padlock.

Article code	Description
<b>063.0100</b>	Surface 386 x 308 mm
<b>063.0110</b>	Surface 300 x 190 mm

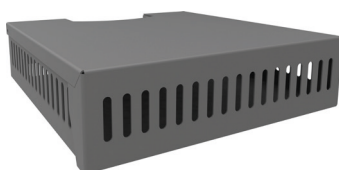

### MEDIA HOUSING

max. 450 x 377 x 114 mm

Protect your valuable equipment by placing it in this lockable media housing. Cables can be run through the back side into the column and the position of the housing can be adjusted continuously over the full length of the column.

**063.0700**



### MINI-PC/THIN CLIENT HOUSING

max. 397 x 218 x 100 mm

Your mini-PC is safely installed and protected from theft and vandalism in this solid steel housing. Cables can be run through the upper side into the column and the housing can be adjusted in height continuously.

Important benefit of this housing is that this housing is placed behind the flat panel.

**063.0710**





- ✓ TÜV Certified
- ✓ DGUV Certified (former BGV-C1)
- ✓ Installation without tools
- ✓ Perfect alignment
- ✓ Compact transport in custom developed flightcases



## Safe & flexible

Besides VideoWall solutions for permanent installation, we also offer solutions with flexibility to install a VideoWall in rental applications.

First of all a matrix construction can be built from divisible stands; where we offer connector bars, tiltable stand heads and a wider mounting pattern to allow utmost stability.

In case a rental company requires to be even more flexible and wishes to select from its rental fleet per location, a wall, truss or floor solution, the Smart Rental Frame offers most flexibility. This frame is available in a 46 or 55 inch ultra narrow bezel solution, with flat panel specific mounting sets. The frame can work as small as a 2 flat panel wide/high solution, to as large as a 4 panel wide/high solution. Of course fully TÜV certified to guarantee a safe installation.

# VIDEOWALLS

## Freestanding on the floor

The accessories below offer the possibility to build a VideoWall configuration from your fully divisible stands.

The stand extension piece of 950 mm (063.0295) is available to extend the fully divisible stands to 2850 mm. Ideal to raise your flat panel above the public, or to use it for a 3x3 VideoWall configuration. By connecting the

stands with our stabilizing bars (063.0900) the set will offer a strong and easy to build up VideoWall construction. Always use two bars between two stands.

A stand head with five-point coupling mounting system (063.1025) is especially developed for our fully divisible stands which are used in a

VideoWall configuration. A bracket with three point coupling (063.03xx) can be added, which by adding the additional coupling bolts can be used as five-point coupling mounting system. A tilt function of +1° till -4° is integrated which helps to align the displays on the stand.

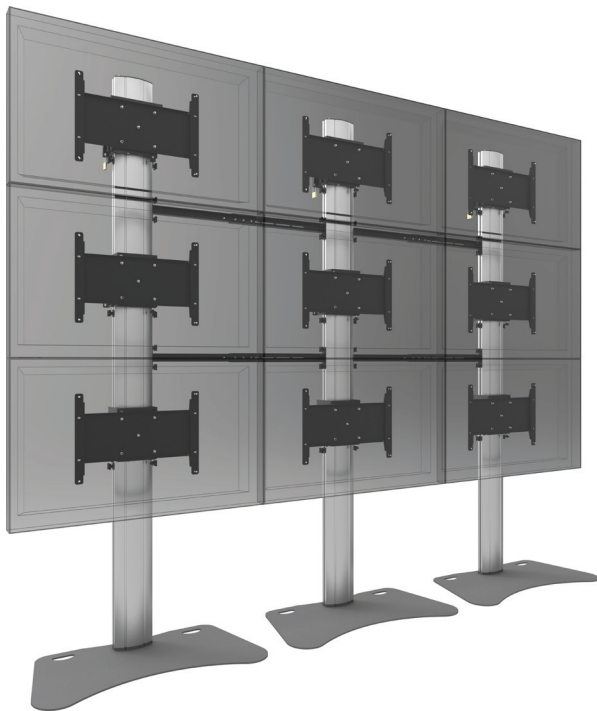

063.1025 Stand head



063.0900 Stabilising bar





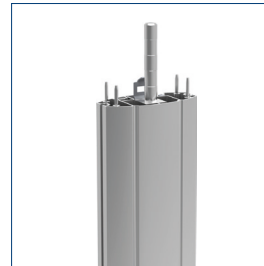

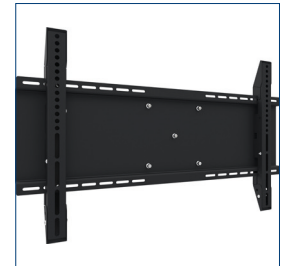

063.0295 Extension piece



Rental bracket



 <b>Colour</b>	
 <b>Max. inch</b>	42 - 55 inch
 <b>Position</b>	Landscape
 <b>Note</b>	Three point coupling
 <b>Required</b>	Brackets, see from page 26

# FLAT PANEL BRACKETS

With three point coupling

All our rental brackets are developed with quick and easy installation in mind.

By means of a three-point coupling system all brackets are easily combined with our truss/wall models and floor stands.



✓ Effortless installation



✓ Landscape & portrait

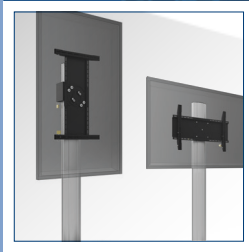

## VESA 200 RENTAL BRACKET

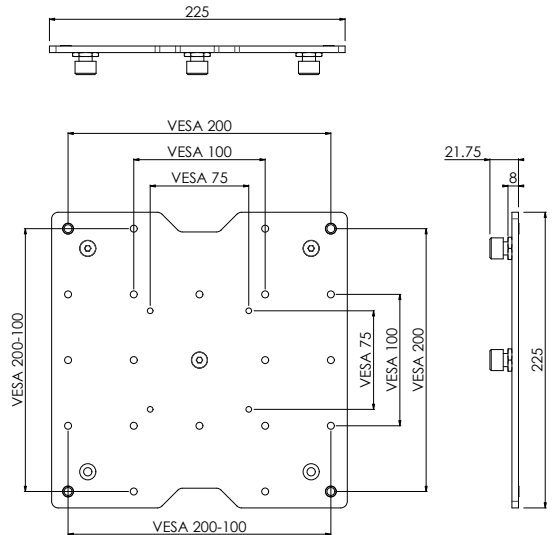
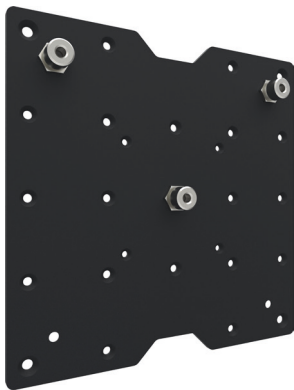





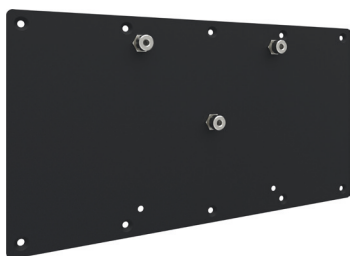

	<b>Colour</b>	●
	<b>Max. load</b>	50 kg
	<b>Position</b>	Landscape & Portrait
	<b>VESA</b>	VESA 75, 100, 200 x 100, 200
	<b>Note</b>	Three point coupling

**Article code**

**063.0300**

## VESA 200, 400 X 200 RENTAL BRACKET



	<b>Colour</b>	●
	<b>Max. load</b>	50 kg
	<b>Position</b>	Landscape & Portrait
	<b>VESA</b>	VESA 200, 400 x 200
	<b>Note</b>	Three point coupling

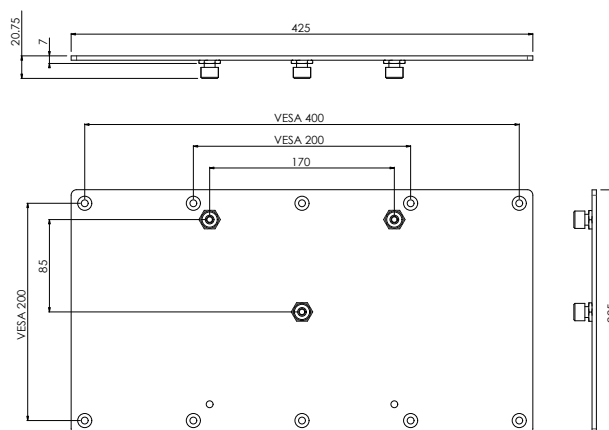







### Article code

063.0305

## VESA 300(-200), 400(-300/-200) RENTAL BRACKET



	<b>Colour</b>	●
	<b>Max. load</b>	80 kg
	<b>Position</b>	Landscape & Portrait
	<b>VESA</b>	VESA 300 x 300/200, 400 x 400/300/200
	<b>Note</b>	Three point coupling
	<b>Accessories</b>	See page 29

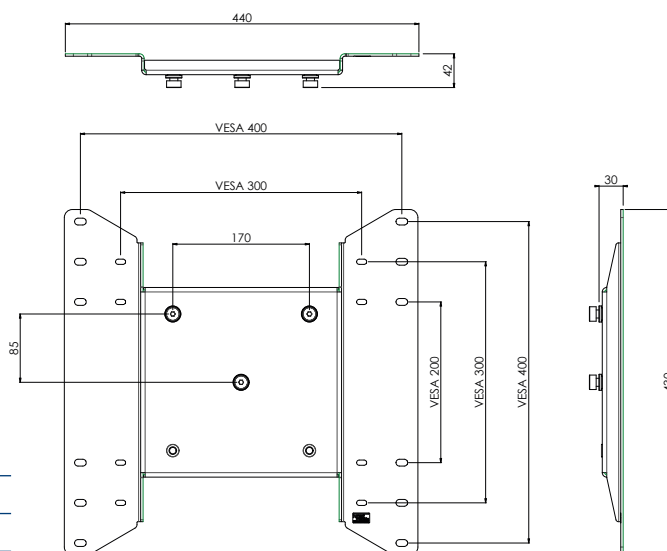

### Article code

063.0310

# FLAT PANEL BRACKETS

With three point coupling

## VESA 300, 400(-200) RENTAL BRACKET

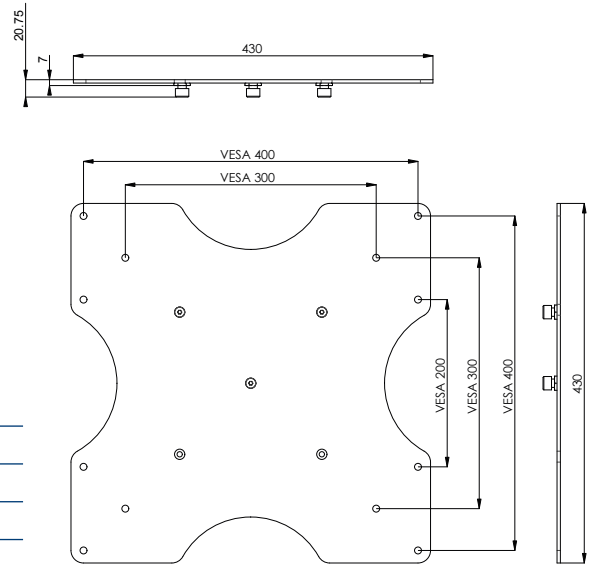
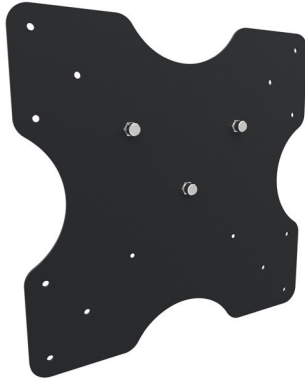

	<b>Colour</b>	●
	<b>Max. load</b>	80 kg
	<b>Position</b>	Landscape & Portrait
	<b>VESA</b>	VESA 300 x 300, 400 x 400/200
	<b>Note</b>	Three point coupling
	<b>Other info</b>	Does not combine with 063.0600 hoist system
	<b>Accessories</b>	See page 29

<b>Article code</b>
063.0315

## VESA 600/800 x 400/200 RENTAL BRACKET

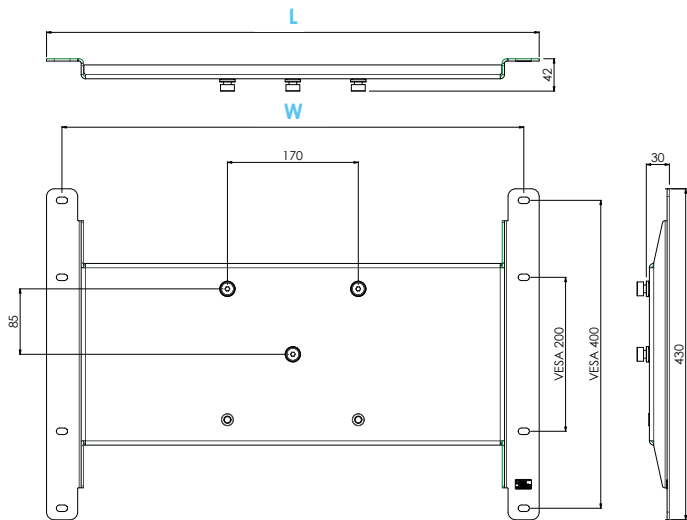
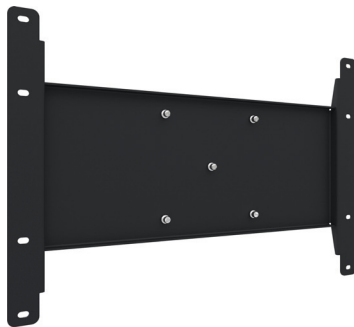

	<b>Colour</b>	●
	<b>Max. load</b>	80 kg
	<b>Position</b>	Landscape & Portrait
	<b>VESA</b>	VESA 600/800 x 400/200
	<b>Note</b>	Three point coupling
	<b>Accessories</b>	See page 29

Article code	Width (W)	Length (L)
063.0320	600 mm	640 mm

### VESA MAX. 800 X 600 RENTAL BRACKET

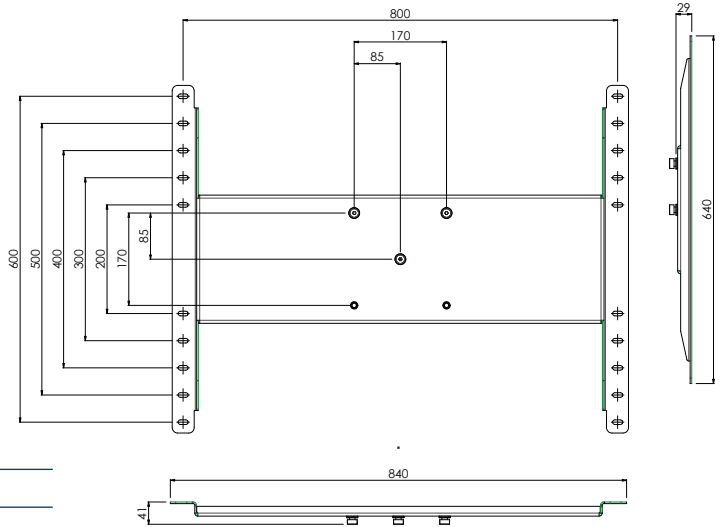
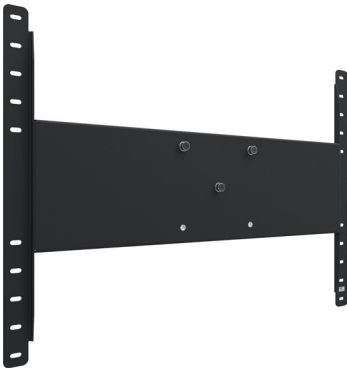

	<b>Colour</b>	●
	<b>Max. load</b>	160 kg
	<b>Position</b>	Landscape & Portrait
	<b>VESA</b>	VESA 800 x 600/500/400/300/200
	<b>Note</b>	Three point coupling

<b>Article code</b>
063.0335

### UNIVERSAL RENTAL BRACKET 800 X 600 MM

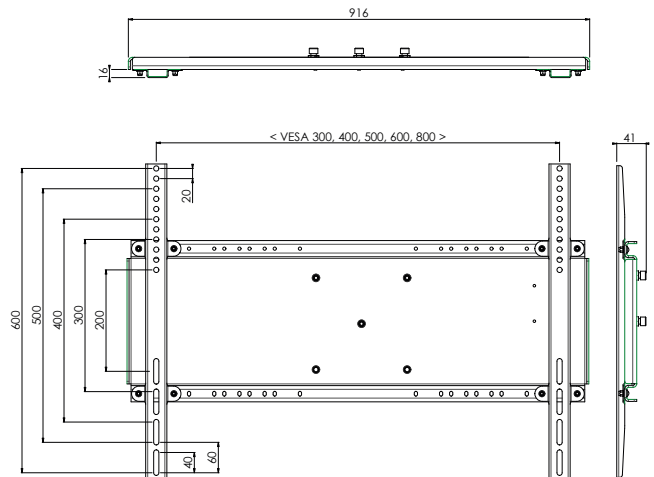

	<b>Colour</b>	●
	<b>Max. load</b>	100 kg
	<b>Position</b>	Landscape & Portrait
	<b>VESA</b>	Max. 800 x 600 mm
	<b>Note</b>	Three point coupling

<b>Article code</b>
052.5005

Accessory for  
063.0310/.0315/.0320 &.0330



### ADAPTERSTRIPS VESA 400 -> VESA 500 HIGH

<b>Article code</b>
063.0306

# FLAT PANEL BRACKETS

With three point coupling

## VESA MOUNT WITH ROTATION

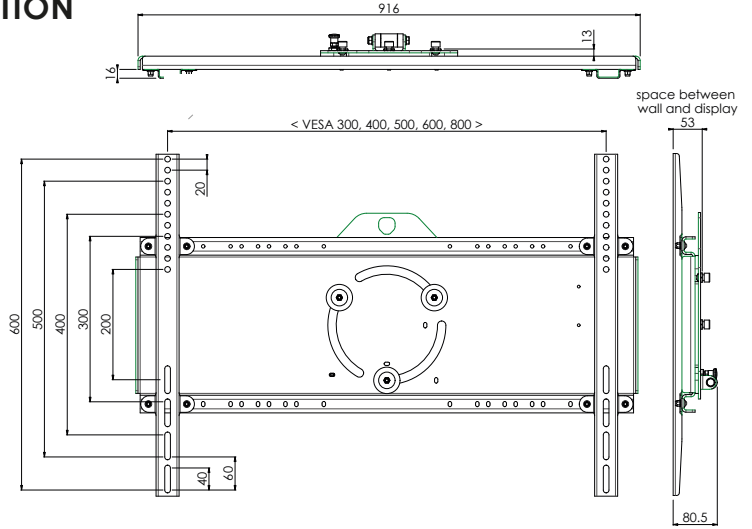
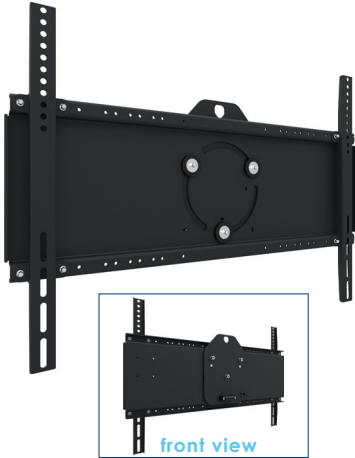

	<b>Colour</b>	●
	<b>Max. load</b>	160 kg
	<b>Position</b>	Landscape & Portrait
	<b>VESA</b>	Max. 800 x 600 mm
	<b>Note</b>	Three point coupling

Article code	Rotation	Other information
052.5070	With rotation 90°	Does not combine with 063.0465 wall-truss module

## PANASONIC LF SERIES VESA 400 RENTAL BRACKET

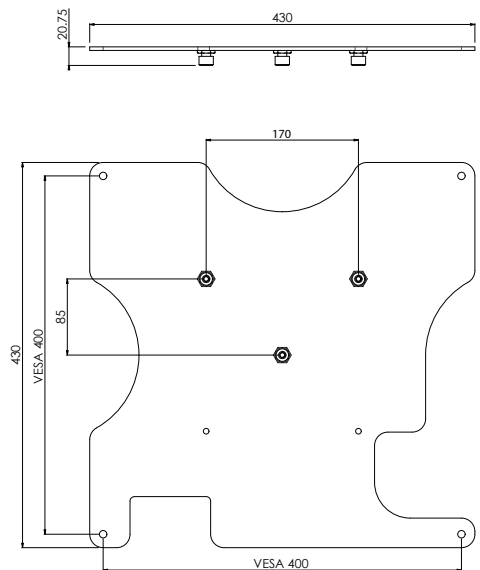

	<b>Colour</b>	●
	<b>Max. load</b>	80 kg
	<b>Max. inch</b>	up to 65 inch
	<b>Position</b>	Landscape & Portrait
	<b>VESA</b>	VESA 400
	<b>Note</b>	Three point coupling
	<b>Other info</b>	Also suitable for Sharp PN-Y425, Y475 & Y555

Article code
PAN.0315-LF



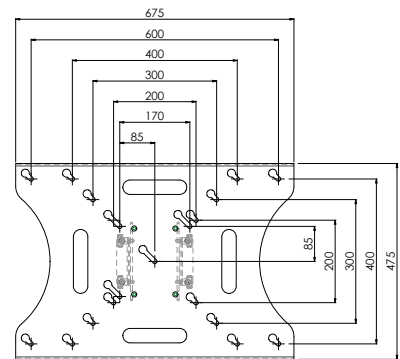
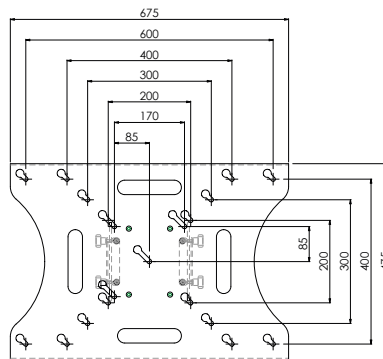
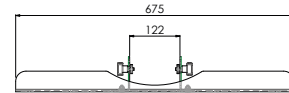
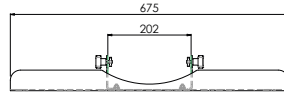
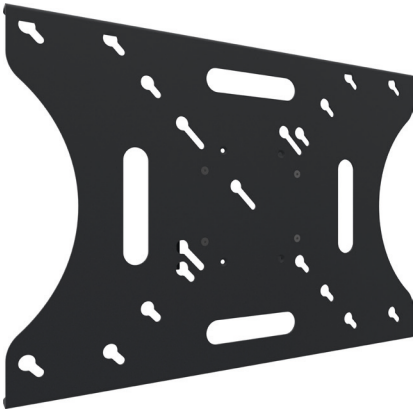

# FLAT PANEL BRACKETS

Direct mounted bracket



## ONE BRACKET FOR VESA 200, 300, 400 AND 600

This rental bracket is suitable for direct mounting (no stand head required), in portrait and landscape position, to all rental floor stands, light series as well as the heavy duty ones.

 <b>Colour</b>	●
 <b>Max. load</b>	120 kg
 <b>Position</b>	Landscape & Portrait
 <b>VESA</b>	200, 300, 400, 600

### Benefits

- ✓ Suitable for Lightweight as well as Heavy Duty Series floor stands
- ✓ No stand head required
- ✓ VESA 200, 300, 400 and 600 in one bracket



# TRUSS MOUNTS

Our product assortment includes several solutions to hang a projector from a truss.

The solutions for projectors up to 25 kg include a ball joint, a ball joint clamp incl. handles to fasten without using tools and a bracket with quarter-turn latches. These components together allow a quick and easy installation of a projector. To mount the projector a projector-specific bracket or a universal bracket (rental version) is required.

The tube sets are electrically insulated, meaning the truss does not need to be taped to prevent screen problems. Furthermore the tube set is fitted with lifting eyes for safety lines.

A projector fine adjustment is added to our assortment for accurate installation. This solution allows a fine adjustment (-20° till +20°) and a 90° degrees rotation is included. With our threaded fine adjustment it is possible to continuously pan and tilt the projector. This set allows direct mounting of the projector with its projector-specific bracket or using a bracket with quarter-turn latches in between. The projector fine adjustment can be mounted to a truss using two trigger clamps.



# TRUSS MOUNTS

With ball joint

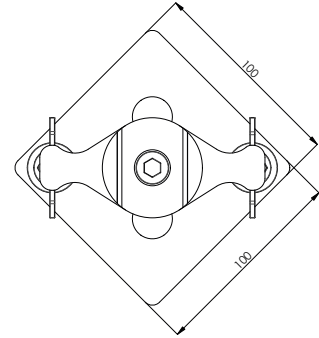
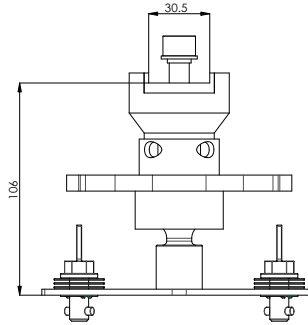

## RENTAL SET 1, 130 MM FIXED FOR TRIGGER CLAMP, EXCLUDING BRACKET

🎨	<b>Colour</b>	●
⚠️	<b>Max. load</b>	30 kg
📋	<b>Note</b>	Tilt +20° / -20°, rotation 360°
⚠️	<b>Required</b>	Projector-specific/universal mount
+	<b>Accessories</b>	See from page 36
i	<b>Other info</b>	Electrical insulation excluding Doughty Trigger Clamp (003.1128)

<b>Article code</b>
002.1641

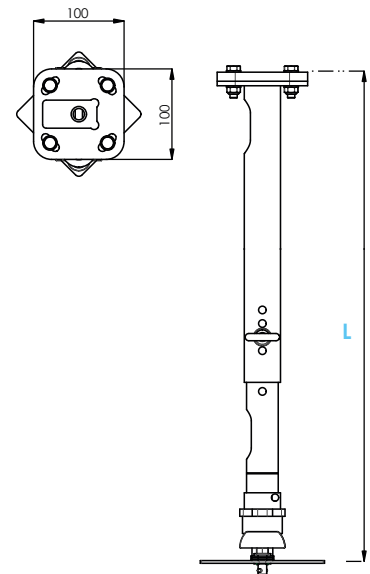

## RENTAL SET 2 - 4, ADJUSTABLE EXCLUDING BRACKET

🎨	<b>Colour</b>	●
⚠️	<b>Max. load</b>	30 kg
📋	<b>Note</b>	Tilt +20° / -20°, rotation 360°
⚠️	<b>Required</b>	Projector-specific/universal mount
+	<b>Accessories</b>	See from page 36
i	<b>Other info</b>	Electrical insulation excluding Doughty Trigger Clamp (003.1128)

Article code	Description	Length (L)
002.1660	Set 2	463 - 713 mm
002.1661	Set 3	713 - 1163 mm

# LIGHTWEIGHT TRUSS MOUNTS

With fine adjustment

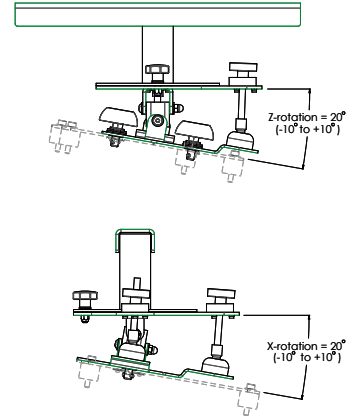
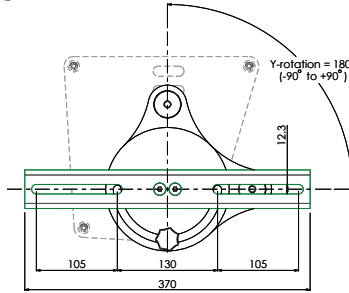

## PROJECTOR FINE ADJUSTMENT EXCL. BRACKET, EXCL 2X TRIGGER CLAMP

	<b>Colour</b>	●
	<b>Max. load</b>	25 kg
	<b>Required</b>	Projector-specific mount
	<b>Accessories</b>	See from page 36
	<b>Other info</b>	Electrical insulation excluding Doughty Trigger Clamp (003.1128)

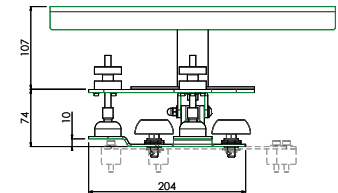

### Article code

002.1650

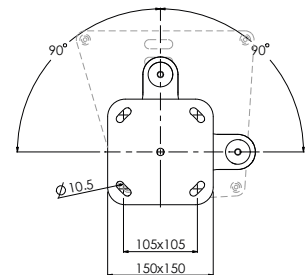
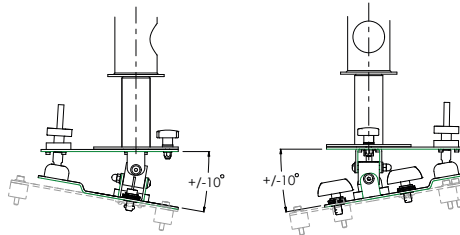

## TUBE SET FINE ADJUSTMENT EXCL. BRACKET

	<b>Colour</b>	●
	<b>Max. load</b>	25 kg
	<b>Required</b>	Projector-specific mount
	<b>Accessories</b>	See from page 36

Article code	Length (L)
002.1670	452 - 1230.5 mm
002.1680	452 - 2230.5 mm
002.1690	452 - 3230.5 mm

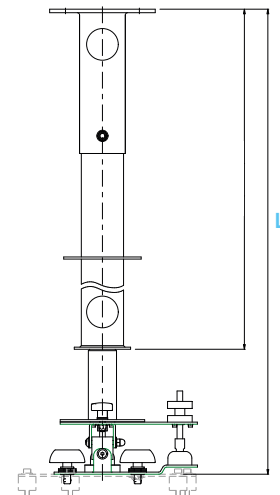

# HEAVY DUTY TRUSS MOUNTS

With fine adjustment



TÜV & DGUV Certified

## RENTAL MOUNT 150 MM FOR PROJECTOR MAX. 250 KG

Our rental mounts ensure a quick and easy installation of projectors in rental situations. The 002.4600 is a heavy duty projector mount for installation of projectors with a maximum weight of 250 kg in a truss.

It offers a tilt function of  $+15^\circ$  until  $-15^\circ$  and a further fine adjustment  $+3^\circ$  until  $-3^\circ$ . The rental mount has to be combined with a projector-specific bracket, please contact us for the one that fits your projector.

The mounting pattern 100 x 100 mm makes it standard suitable to the most Panasonic and Barco stack frames.

This rental mount is thoroughly tested and has TÜV certification.

🎨	<b>Colour</b>	●
⚠️	<b>Max. load</b>	250 kg
!	<b>Required</b>	Projector-specific mount
📄	<b>Note</b>	Rotation $360^\circ$
+	<b>Accessories</b>	See from page 36

Article code

002.4600

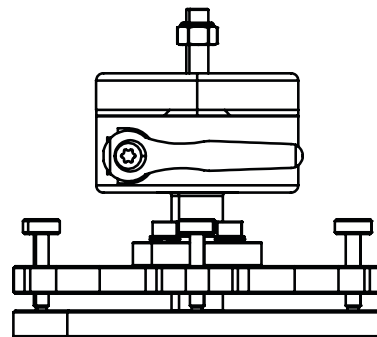
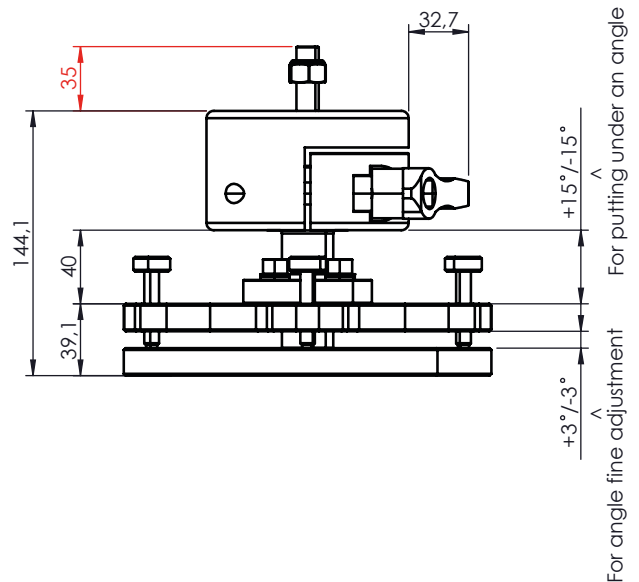

# ACCESSORIES

For truss mounts

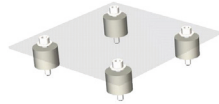

## FIXED MOUNTED SPACERS for rental set 1-4

The perfect solution for keeping all material together in situations where you have to regularly detach the projector from the mount.

003.1125



## DOUGHTY TRIGGER CLAMP

for rental set 1-4, 002.1650 and  
002.1670-90 series

This Doughty Trigger Clamp can be used for truss mounting with the SmartMetals rental mounts (002.16xx, 002.2441, 002.2041) and the wall/truss module (art. nr.: 063.0460).

003.1128



## PROJECTOR-SPECIFIC BRACKET for rental set 1-4, 002.1650 and 002.1670-90 series

The projector-specific bracket is custom-made for your type and brand of projector. With the design, we have taken into account the position of the lens and the projector's centre of gravity. Valuable time and money will be saved with the use of projector-specific brackets.

002.1001



## UNIVERSAL BRACKET for rental set 1-4, max. Ø 378 mm

Besides the projector specific bracket (custom-made to projector brand and type) a universal bracket is available as well.

002.1003

TÜV & DGUV Certified

## TRUSS MOUNTING BAR for rental mount 002.4600

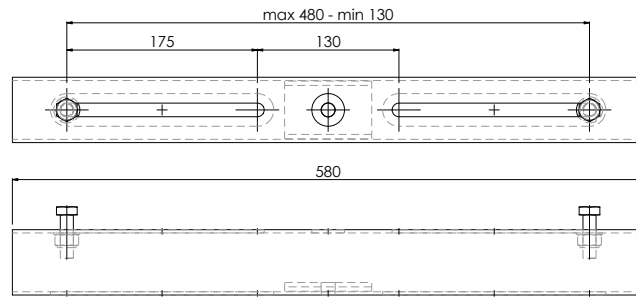

002.4610

## BRACKET FOR BARCO HDX AND HDF SERIE FRAMES (MAX. 250 KG) for rental mount 002.4600

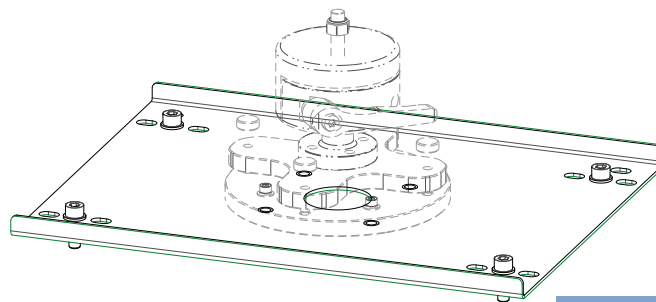
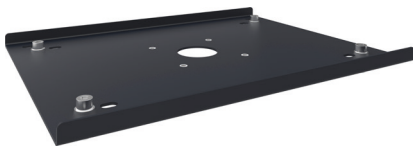

002.4620

## LARGE UNIVERSAL BRACKET for frames mounted to 002.4600

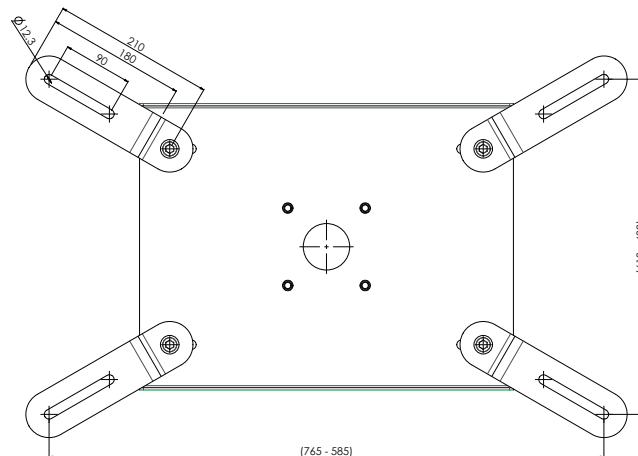

002.4621



- ✓ TÜV Certified
- ✓ DGUV Certified (former BGV-C1)
- ✓ Lightweight
- ✓ Better manageable
- ✓ Easier to transport
- ✓ Also available for the Epson L and NEC PA Series

## Stacking 2.0

Aluminium, lightweight, solid, fitted with a removable front, fine adjustment over 3 axes and still the most affordable frame on the market. This is the summary of a new line SmartMetals stack frames. The stack frames are available in different standard sizes and can be used independently with a projector specific mount. By means of the removable front, all models can be combined with projectors which are fitted with ultra-short throw or wide angle lenses. The frames are connected easily and are fitted with a 100x100mm mounting pattern for an adjustable truss adapter (002.4600). Using the 112.1019 truss mounts the stack frames can also be installed for a floor as well as portrait projection.

# STACK FRAMES

## Small Series



**TÜV & DGUV Certified**

	<b>Colour</b>	●
	<b>Max. load</b>	100 kg
	<b>Required</b>	Projector mount (excl.), pls contact us
	<b>Accessories</b>	See page 40
	<b>Other info</b>	Max. stacked weight under top frame 275 kg

Article code	Description	Max. projector size (W x L x H)
<a href="#">112.4160</a>	Small 160	500 x 560 x 160 mm
<a href="#">112.4200</a>	Small 200	500 x 560 x 200 mm
<a href="#">112.4210</a>	Small 210	590 x 500 x 210 mm <i>(deviating specifications, please see below)</i>
<a href="#">112.4270</a>	Small 270	500 x 560 x 270 mm

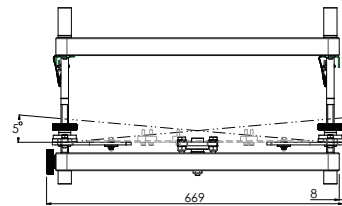
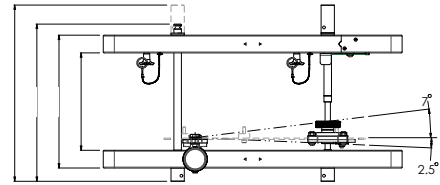
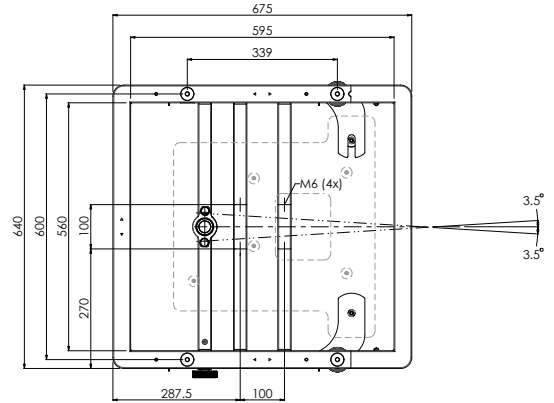

Specifications for 112.4210 only:

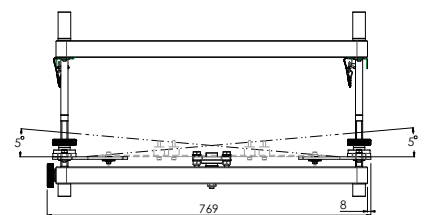
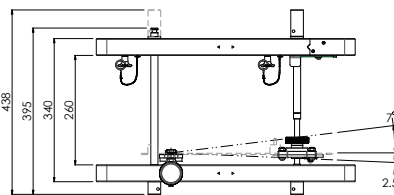
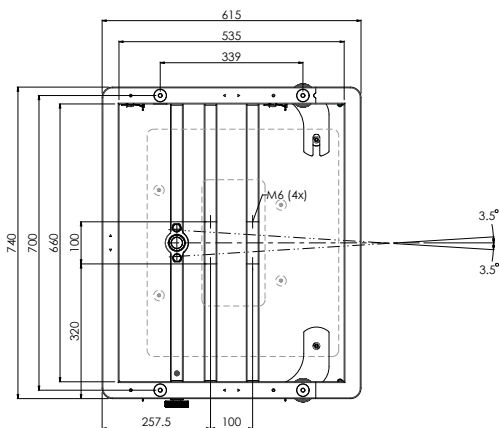



# STACK FRAMES

## Medium Series

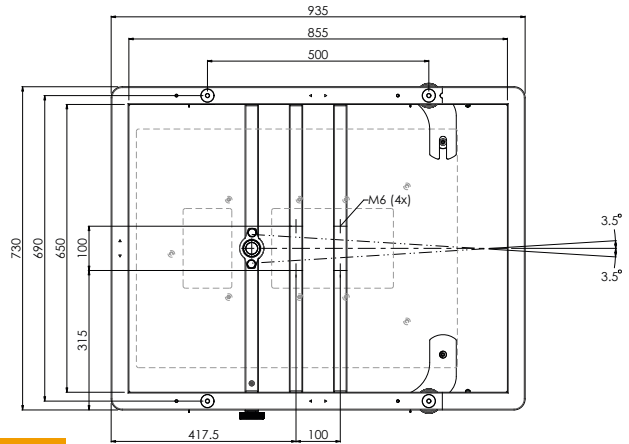

**TÜV & DGUV Certified**

	<b>Colour</b>	●
	<b>Max. load</b>	100 kg
	<b>Required</b>	Projector mount (excl.), pls contact us
	<b>Accessories</b>	See page 40
	<b>Other info</b>	Max. stacked weight under top frame 275 kg

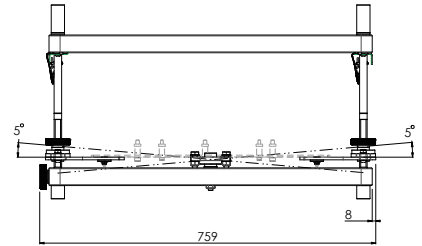
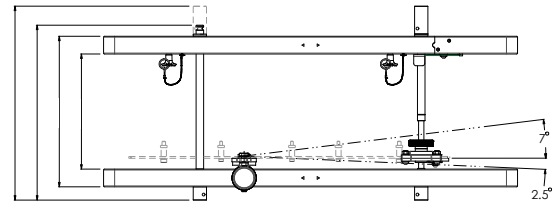

Article code	Description	Max. projector size (W x L x H)
112.5200	Medium 200	590 x 820 x 200 mm
112.5270	Medium 270	590 x 820 x 270 mm
112.5350	Medium 350	590 x 820 x 350 mm

## Accessories for stack frames



**DOUGHTY TRIGGER CLAMP**

003.1128

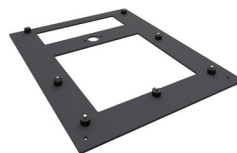

**PROJECTOR SPECIFIC BRACKET**

112.1001



**TRIGGER CLAMP COUPLING SET**

112.1018

# STACK FRAMES

## Large Series



TÜV & DGUV Certified

	<b>Colour</b>	●
	<b>Max. load</b>	100 kg
	<b>Required</b>	Projector mount (excl.), pls contact us
	<b>Accessories</b>	See page 40
	<b>Other info</b>	Max. stacked weight under top frame 275 kg

Article code	Description	Max. projector size (W x L x H)
112.6270	Large 270	660 x 820 x 270 mm
112.6350	Large 350	660 x 820 x 350 mm
112.6425	Large 425	660 x 820 x 425 mm

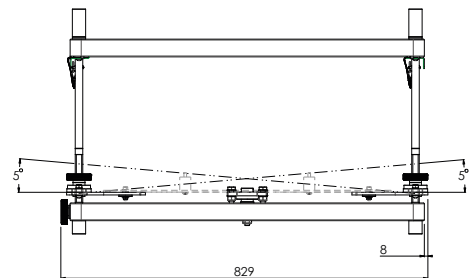
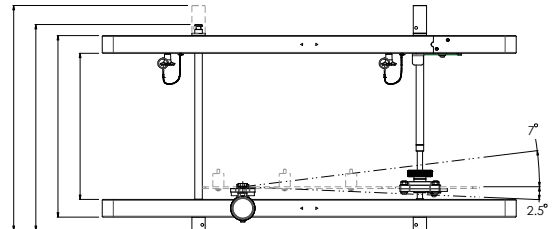
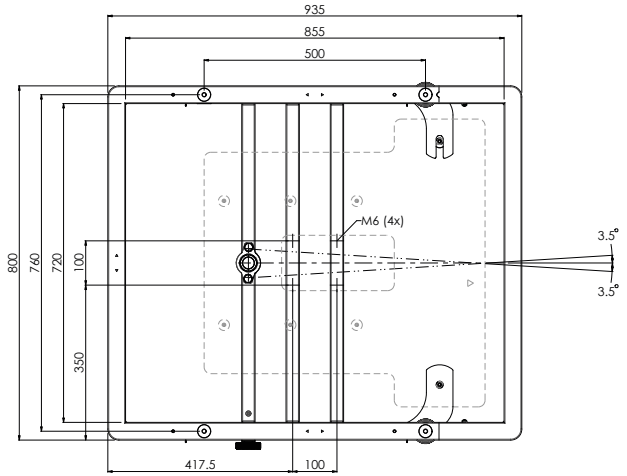

TÜV & DGUV Certified



**STACKFRAME  
CLAMP**  
(40 x 40 tubes)

112.1019



### SCAFF PIPES, Ø 48 mm

This tube with a diameter of 48 mm can be mounted to the trigger clamps and then with a double truss clamp to most trusses.

Article code	Description
112.1015	Scaff pipe small 600 mm
112.1016	Scaff pipe large 1000 mm

# PROJECTOR FLOOR STAND

The projector support 063.0150 has a tilt function from  $-15^{\circ}$  till  $+15^{\circ}$  and dimensions 600 x 600 mm, making it suitable for most projectors with a maximum weight up to 30 kg.

Combined with a SmartMetals back to back stand (062.2200 for fixed installations or 062.2000 for rental purposes) the support becomes a projector floor stand.

Through the cable entry in the support the cables are ran into the hidden cable ducts of the floor stand.

After installation the projector can be secured to the platform with straps.

The support and stand 062.2000 can be stored in a flightcase for compact, easy and safe transport.

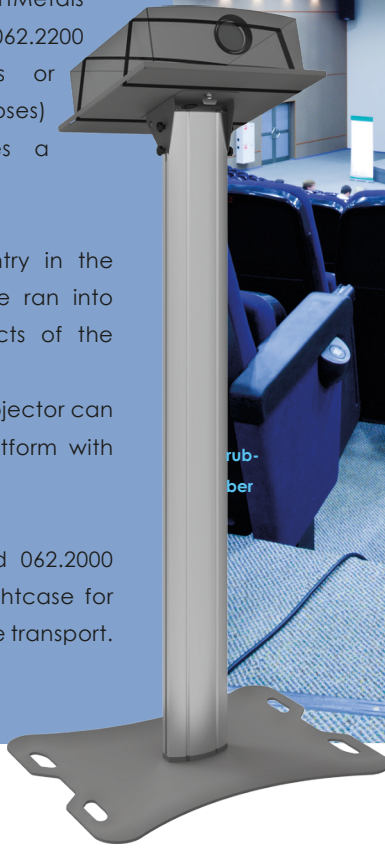

## BENEFITS

- ✓ Anti slip surface
- ✓ Projector support is tiltable  $-15^{\circ}$  /  $+15^{\circ}$
- ✓ Projector secured to support
- ✓ Stable floor solution

COMBINE 063.0150 & 062.2000



## TILTABLE PROJECTOR SUPPORT 600 X 600 MM

Colour ●  
Max. load 30 kg

Article code

063.0150

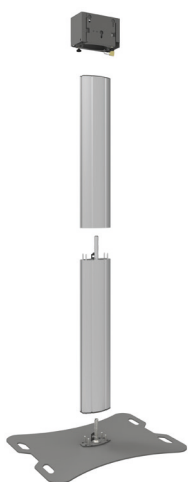
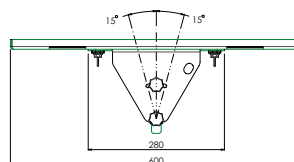
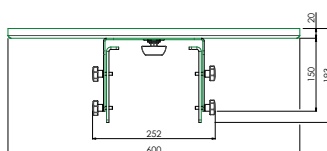
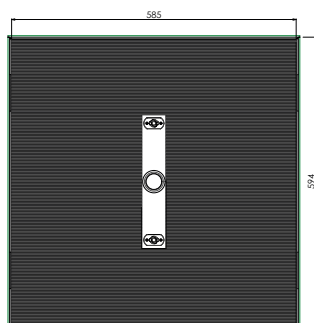

## DIVISIBLE STAND BACK TO BACK

Colour ●  
Max. load 100 kg  
Max. inch 2x Max. 65 inch  
Position Landscape & Portrait

Article code

062.2000

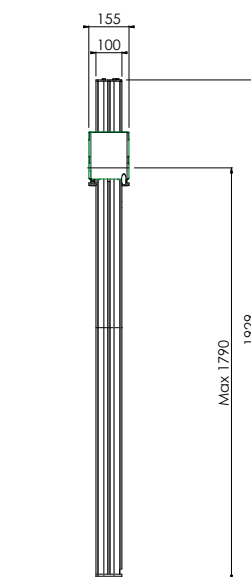
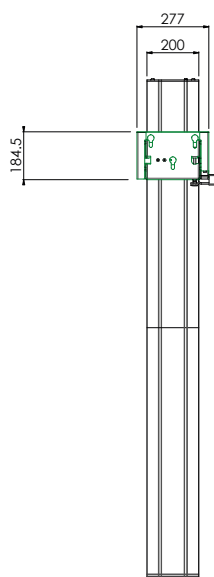
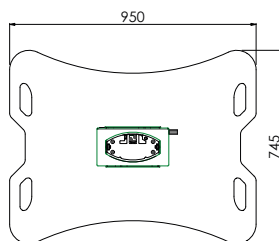



20 horizontal lines for writing









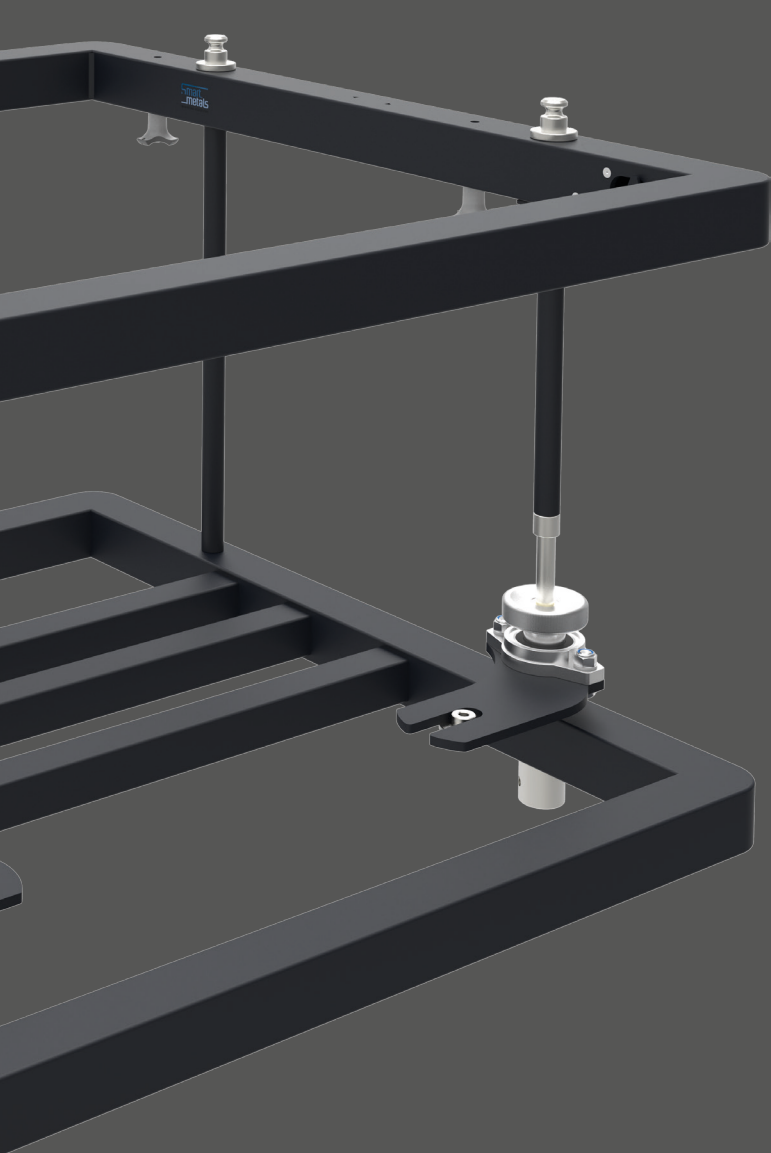

## RENTAL

### Address

SmartMetals Mounting Solutions B.V.  
Pascalweg 13  
4104 BE CULEMBORG  
The Netherlands

### Telephone

+ 31 (0)88 70 60 100

### Email & Website

info@smartmetals.nl  
www.smartmetals.nl

## 2020 - 2021 Product Catalogue - Rental

The information contained in this catalogue is to be used only as a guide to assist with product selection. The products features and technical drawings set forth in this catalogue are subject to change due to product innovations. Please consider information on our website [www.smartmetals.nl](http://www.smartmetals.nl) in any case leading.